















# LEGEND

-  STORMWATER DRAINAGE
-  EASEMENT FOR DRAINAGE OF WATER 1.5m WIDE
-  EASEMENT FOR MAINTENANCE, ACCESS & OTHER PURPOSES 0.9m WIDE
-  SEWER CONNECTION
-  WATER CONNECTION
-  GAS CONNECTION
-  ELECTRICAL CONNECTION
-  LV PILLAR
-  STREETLIGHT COLUMN
-  TELECOMMUNICATION CONNECTION
-  RETAINING WALL
-  PROPOSED STREET TREE
-  CONTOUR
-  PROPOSED CONCRETE FOOTPATH



LOT 7318

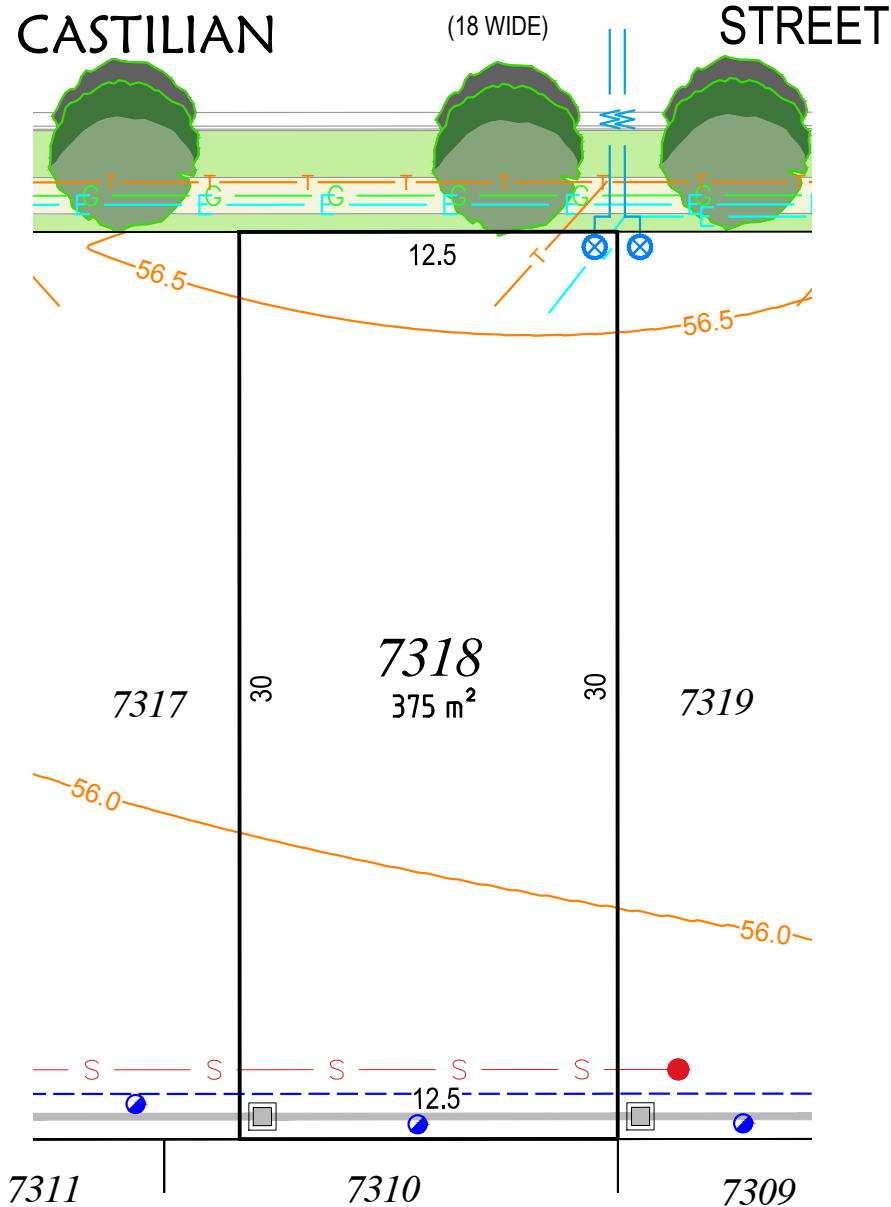

**Note**

1. Dimensions and areas are subject to the registration of the deposited plan.
2. For restriction on the use of the land, positive covenants and location of easements and other requirements, refer to deposited plan, 88B instrument and contract.
3. Services shown diagrammatically only.
4. Prospective purchasers are to make their own enquiries with respect to the availability and location of services.
5. All care has been taken in the preparation of this brochure but no responsibility is taken for any errors or omissions.
6. Easement positions may vary subject to final work as executed survey.
7. Contours are subject to final onsite grading and trimming.
8. Prospective purchasers are to make their own enquiries with respect to final levels.

SCALE 1:250



STAGE 7D



Let's Grow Here Together.

Disclaimer: This material has been produced by The Hills of Carmel and associated entities and their appointed Agent and consultants for marketing and promotional purposes only. The Hills of Carmel would like to advise all prospective purchasers or investors to obtain independent advice from a suitably qualified person such as a solicitor, accountant or financial adviser: and to make and rely on their own enquiries and investigations in relation to all statements, predictions and opinions contained in this material before purchasing land at this development. This material is intended as a general guide only and should not be relied upon in making a decision to purchase land at this development. The Hills of Carmel and associated entities disclaim all liability and responsibility for any loss, damage or claim of whatever nature suffered, sustained or incurred by any person, corporation or other legal entity which arises out of any allege reliance on the contents of this material.